

# Data Sheet



Article number: 604133040040

Description: Taper bored timing belt pulley  
HTD 40 14M 40 TL 2517

## Measures

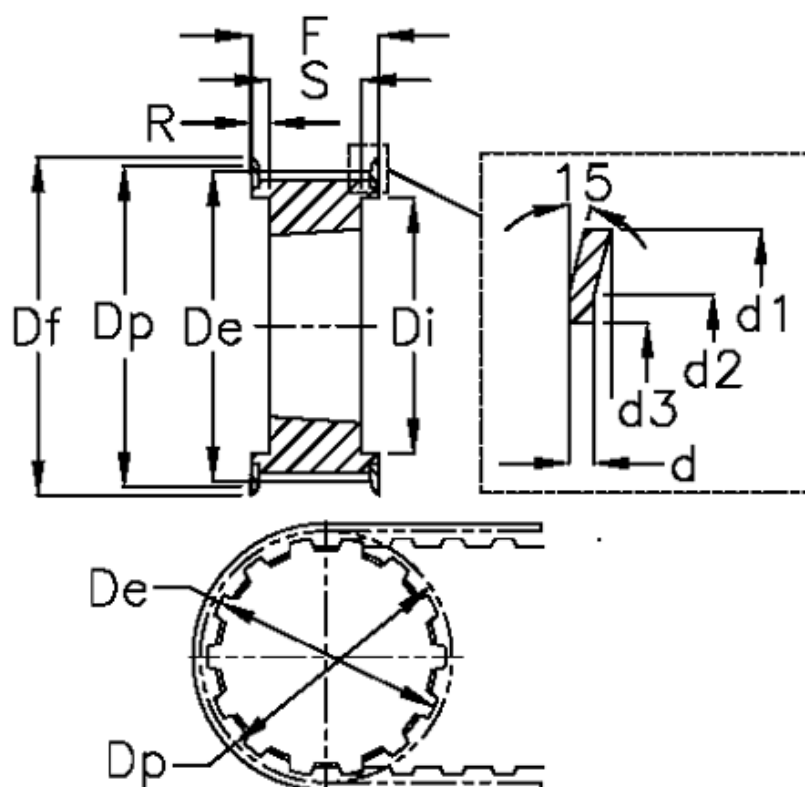

d = 2.5	F = 54	Weight = 6
d1 = 188	Flange type = F56	Width = 40
d2 = 176	For bushing = 2517	
d3 = 150	Max bore = 60	
De = 175.49	r = 4.5	
Df = 188	S = 45	
Di = 138	Tooth number = 40	
Dp = 178.25	Type = 14M	